

Zahnmedizin

Dentistry

DFS

Dental Future Systems

D I A M O N

www.dfs-diamon.de

2019 / 2020

**HOCHWERTIGE
UND INNOVATIVE
DENTALPRODUKTE
SEIT MEHR ALS
30 JAHREN.**

**DEVELOPING AND
MANUFACTURING
INNOVATIVE
DENTAL PRODUCTS
FOR OVER 30 YEARS.**

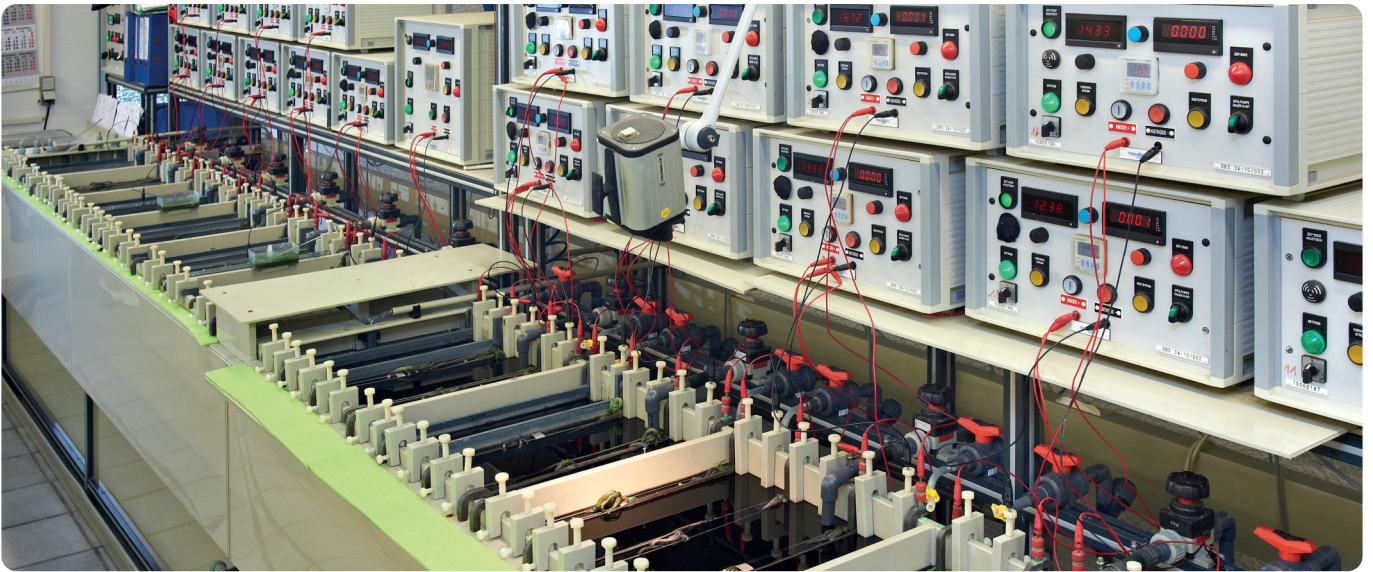

DFS DIAMON: Seit über 30 Jahren erfolgreich in Entwicklung, Produktion und Vertrieb zahntechnischer Erzeugnisse.

DFS DIAMON: excellence in product development, manufacturing and distribution of dental medical products for over 30 years.



Inhaltsverzeichnis / Content

	Seite / page	Seite / page	
EN ISO Norm / EN ISO code	4	ENDO Instrumente / Endodontic instruments	55
Diamantwerkzeuge / Diamond tools	5-41	Zirkoninstrumente / Zirconia tools	56-57
FG Diamanten / FG diamonds	6-27	Circopol N	56
FG Diamanten minimal invasiv	23	Trepanierer Zirkon / Trepanation instrument zirconia	56
FG Diamanten kurz / FG diamonds short shank	24-26	FG Diamanten Zirkon / FG diamonds for zirconia	57
FG Diamanten lang / FG diamonds long shank	27	Kronentrenner Zirkon / Crown cutter zirconia	57
FG Diamanten für ältere Patienten / FG diamonds for senior patients	27	Zircut® Kronentrenner / Zircut® Crown cutter	57
Diamanten WST / CA diamonds	28-29	Kronentrenner SOFTY-longlife / Crown Cutters SOFTY-longlife	58
Turbo Laser	30	Crossy	58
Turbo Comp	31	Wunderkugel / Wonder Ball	58
Redux	32	Hartmetallinstrumente / Carbide burs	59-68
FG Piranhas	33-38	Hartmetallinstrumente / Carbide burs	59-63
Präparations-Sets / Preparation kits	39-43	Finierer / Finishing burs	64-65
Diafutur®	39-40	Kronentrenner / Crown cutters	66-67
Inlay-, Kronen- und Brücken Präparationskit / Allround prep tool kit	41	KFO-Entferner / Orthodontic carbide bur	67
Kronen- und Brückenpräparationskit / Crown prep tool kit	41	Instrumente für die Parodontologie / Instruments for periodontics	68
Finier- und Polierkit für Keramik und Komposit / Finishing & polishing kit ceramics & composites	42	Perio Diamanten / Perio diamonds	68
Präparationskit Vollkeramik / Metal-free prep tool kit	42	Reduzierstücke / Reducers	69
Präparationskit Veneers / Veneer prep tool kit	43	Mini-Flex	69
Bohrerstände / Trays	43	Gewebestanzen / Tissue punches	70
Handyfix	43	PreciCut® Soft Tissue Trimmer	71
Polierer / Polishers	44-50	Orangenreiniger / Cleanorange	72
RTS	44-47	Spiegelgriffe / Mirror handles	72
Ultra-Light	46	Okklusionsspray / Occlusion spray	73
Uporal®	46	Reinigung und Desinfektion / Cleaners and disinfectants	74-75
Diafix® Oral	46	Erläuterung der Piktogramme / Explanation of pictograms	76
Prophylaxe Polierer	48	Hinweis zum E-Labbling / Information regarding E-Labbling	77
2ceram Keramikpolierer / 2ceram polishers for ceramics	49	Index	78
2metal Polierer / 2metal polishers	49		
2comp Kompositpolierer / 2comp polishers for composites	50		
Durocomp Kompositpolierer / Durocomp polishers for composites	50		
Chirurgie / Surgery	51-55		
Stahlinstrumente / Steel surgical burs	51-52		
Hartmetallinstrumente Surgical burs carbide	52-54		
Diadoss Fräser / Diadoss Cutters	55		

Die Standardisierung von Werkzeugen nach der ISO-Norm 6360

The standardisation of tools according to ISO-norm 6360

Von der Internationalen Standardisierungsorganisation (ISO) wurde eine Reihe von Konventionen hinsichtlich der Bezeichnung von rotierenden Werkzeugen in der Dentaltechnik eingeführt. Jedes Werkzeug wird mit einem international eindeutigen **ISO-Nummerncode** gekennzeichnet, der aus 15 Ziffern in 5 Gruppen besteht und gleichzeitig die **Beschreibung der Werkzeugeigenschaften** beinhaltet.

*In order to achieve conformity the International Organization for standardization (ISO) has defined a standard description of rotary instruments used in the dental industry. Each instrument is assigned a distinct **ISO number code** which is made up of 15 digits in 5 subgroups and simultaneously contains **the specification for each instrument**.*

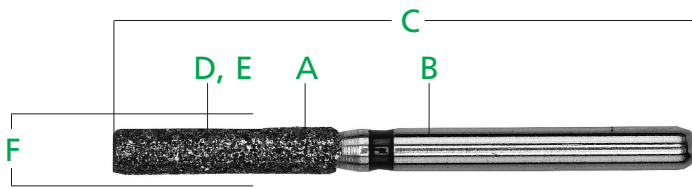

ISO-Nr.	806	314	112	524	016
	A	B,C	D	E	F

- A Werkstoff des Arbeitsteils, z.B. 806 (galvanische Diamanten)
Material of the working part, e.g. 806 (electroplated diamonds)
- B,C Schaft und Gesamtlänge, z.B. 314 für FG
Shank and total length e.g. 314 for FG
- D Form und Ausführung z.B. 112 für eine zylindrische Form
Shape, e.g. 112 for a cylindrical shape
- E Körnung, z.B. 524 für mittlere Körnung
Particle Size, e.g. 524 for medium / standard grit
- F Nenngröße, größter Durchmesser des Arbeitsteils in 0,1 mm
Size, largest diameter of the working part in 0,1 mm

ISO Farbcode / ISO color code

----- Arbeitsablauf (Diamanten)/sequence (diamonds) ----->

extragrob/extracoarse
schwarz/black



grob/coarse
grün/green

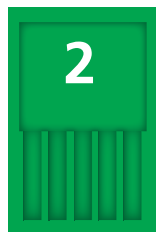

mittel/medium
blau/blue



fein/fine
rot/red



superfein/superfine
gelb/yellow

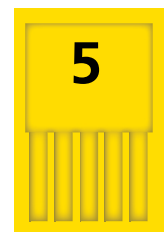

- ✓ **Hinweis:**
Es sollte nicht mehr als eine Farbe übersprungen werden; z.B. 1 auf 3 ist möglich, 1 auf 5 ist nicht empfehlenswert, da zu hoher Material- oder Zeitaufwand.

Note:
No more than one step should be omitted. For example moving from coarse to fine is ok, but switching from coarse to superfine will result in inefficient use of time and / or material.

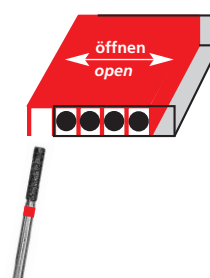

Die praktische Schiebeverpackung für die Entnahme der einzelnen Werkzeuge.

Instruments can be easily accessed by sliding the lid of the packaging.

FG Diamanten – Ihre Vorteile

FG diamonds – your benefits

Die 2-Lagen diamantierten FGs haben bis zu 70% höhere Standzeit als herkömmliche FGs.
The two-layer diamond coated FGs last about 70% longer than conventional one-layer FG diamonds.

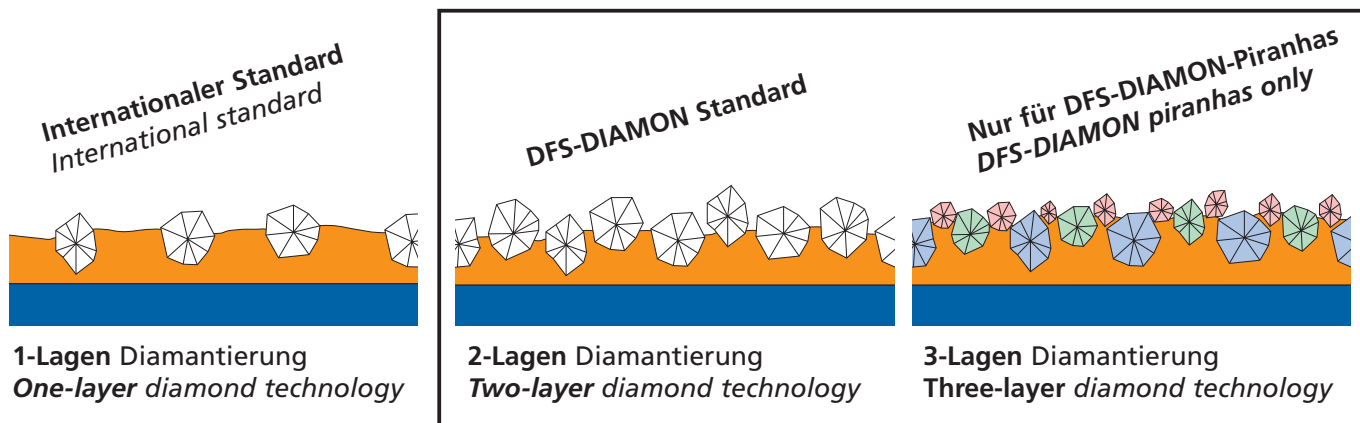

- ✓ **Ausgezeichnete Qualität**
Excellent quality
- ✓ **Made in Germany**
- ✓ **Fertigung nach EN ISO 13485, ihre Sicherheit für höchste Qualität**
Manufactured according to EN ISO 13485, your assurance for highest quality
- ✓ **Farbcodiert für optimale Effizienz**
Color coded for optimal efficiency
- ✓ **Um beste und schnellste Ergebnisse zu erzielen empfehlen wir, die Instrumente in der Reihenfolge der Farbcodierung einzusetzen: von dunkel nach hell oder 1 bis 5.**
For best results we recommend using the instruments in sequence following the color code: from dark to light or 1 to 5.
- ✓ **Der Farbring am Instrument und die Farbe der Verpackung entsprechen dem ISO Code.**
The color ring on the instrument shank and the color of the packaging correspond to the ISO code.

Anwendungssymbole / Usage symbols



FG Diamanten – Royal line in 2-Lagen Diamantierung

FG diamonds – Royal line with two-layer diamond technology

ISO Nr.: 806 314 F 504 superfein / superfine

806 314 F 514 fein / fine

806 314 F 524 mittel / medium









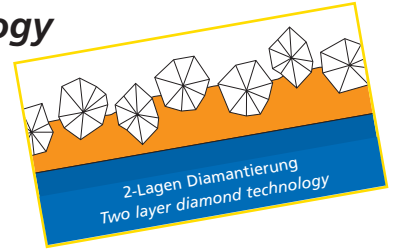







806 314 F 534 grob / coarse













806 314 F 544 extragroß / extracoarse











Drehzahl / speed







30' - 300000 Upm / rpm



 801	  														
		F :	001	001	001	001	001	001	001	001	001	001	001	001	001
		d :	008	009	010	012	014	016	018	021	023	025	027	029	035
		KL/hl :	-	-	-	-	-	-	-	-	-	-	-	-	-
P :	1	1	1	1	1	1	1	2	2	2	3	3	3		
		<u>530064</u>	<u>530074</u>	<u>530014</u>	<u>530024</u>	<u>530034</u>	<u>530046</u>	<u>530054</u>	<u>530244</u>	<u>530284</u>	<u>530254</u>	<u>530006</u>	<u>530008</u>		
		<u>530066</u>	<u>530076</u>	<u>530016</u>	<u>530026</u>	<u>530036</u>	<u>530048</u>	<u>530056</u>	<u>530246</u>	<u>530286</u>	<u>530256</u>	<u>530006</u>	<u>530008</u>		
		<u>530068</u>	<u>530078</u>	<u>530018</u>	<u>530028</u>	<u>530038</u>	<u>530048</u>	<u>530058</u>	<u>530248</u>	<u>530288</u>	<u>530258</u>	<u>530006</u>	<u>530008</u>		
		<u>530065</u>	<u>535235</u>	<u>530075</u>	<u>530015</u>	<u>530025</u>	<u>530035</u>	<u>530045</u>	<u>530055</u>	<u>530245</u>	<u>530285</u>	<u>530255</u>	<u>530005</u>		
		<u>535238</u>	<u>530073</u>	<u>530013</u>	<u>530023</u>	<u>530033</u>	<u>530043</u>	<u>530053</u>	<u>530243</u>	<u>530368</u>	<u>530253</u>	<u>530005</u>	<u>530005</u>		

 802	  										
		F :	002	002	002	002	002	002	002	002	
		d :	008	009	010	012	014	016	018	021	023
		KL/hl :	2,5	2,5	2,5	3	3	3	3,5	4	4,5
P :	1	1	1	1	1	1	1	2	2		
		<u>530278</u>	<u>535648</u>	<u>530298</u>	<u>530086</u>	<u>530088</u>	<u>530318</u>	<u>530338</u>	<u>530098</u>		
		<u>530278</u>	<u>535648</u>	<u>530295</u>	<u>530085</u>	<u>530315</u>	<u>530335</u>	<u>530095</u>	<u>536238</u>		
		<u>530278</u>	<u>535648</u>	<u>530298</u>	<u>530088</u>	<u>530318</u>	<u>530338</u>	<u>530098</u>	<u>535968</u>		
		<u>530278</u>	<u>535648</u>	<u>530295</u>	<u>530085</u>	<u>530315</u>	<u>530335</u>	<u>530095</u>	<u>530093</u>		

 805	 									
		F :	010	010	010	010	010	010	010	010
		d :	009	010	012	014	016	018	022	023
		KL/hl :	1	1	1,5	1,5	1,5	1,6	2	2
P :	1	1	1	1	1	1	2	2		
		<u>530178</u>	<u>530168</u>	<u>530108</u>	<u>530118</u>	<u>530128</u>	<u>530138</u>	<u>530148</u>	<u>530188</u>	
		<u>530178</u>	<u>530165</u>	<u>530105</u>	<u>530115</u>	<u>530125</u>	<u>530135</u>	<u>530148</u>	<u>530188</u>	
		<u>530178</u>	<u>530168</u>	<u>530108</u>	<u>530118</u>	<u>530128</u>	<u>530138</u>	<u>530148</u>	<u>530188</u>	
		<u>530178</u>	<u>530165</u>	<u>530105</u>	<u>530115</u>	<u>530125</u>	<u>530135</u>	<u>530148</u>	<u>530188</u>	

 805	  			
		F :	014	014
		d :	018	023
		KL/hl :	0,7	1
P :	1	2		

Alle Royal Line FG Diamanten sind zu 5 Stück verpackt.
 F = ISO-Figur-Nr. · KL = Kopflänge in mm
 d = Durchmesser in 1/10 mm · P = Preiskategorie

All royal line FG diamonds are packed as 5 pieces.
 F = ISO-Shape-No. · hl = head length in mm
 d = diameter in 1/10 mm · P = price category







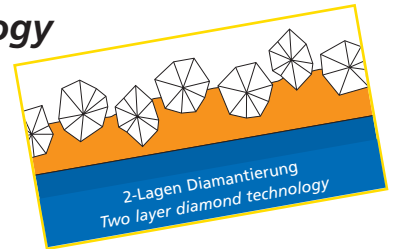

FG Diamanten – Royal line in 2-Lagen Diamantierung





FG diamonds – Royal line with two-layer diamond technology

ISO Nr.: 806 314 F 504 superfein / superfine
 806 314 F 514 fein / fine
 806 314 F 524 mittel / medium
 806 314 F 534 grob / coarse
 806 314 F 544 extragrob / extracoarse

Drehzahl / speed
 30' - 300000 Upm / rpm









 806	F :	019	019	019	019	019	019	019
	d :	008	010	012	014	016	018	023
	KL/hl :	2,2	2,2	3	3	3	3,2	4
	P :	1	1	1	1	1	1	2
								

 813	F :	032	032	032
	d :	010	014	016
	KL/hl :	1,4	1,6	1,8
	P :	1	1	1
				

530348 530206 530214
 530208 530218 530228
 530205 530215 530225 530238
 530223 530235 536518 535668







536208 530498 530528
 530495 530525 530523

 899	F :	033	033	033
	d :	021	027	031
	KL/hl :	6,5	7	7
	P :	2	2	3
				

 811	F :	038	038
	d :	031	033
	KL/hl :	4,5	4,5
	P :	3	3
			

530538 530546
 530535 530548 530558
 530545 530555

530568 535638
 535635 535633

 811	F :	039	039	039	039	039
	d :	033	037	040	045	047
	KL/hl :	4,5	7	7	7	7
	P :	3	3	3	3	3
						

530308 530598 535368 530588
 530305 530593 535365 530325 530585
 530303

Alle Royal Line FG Diamanten sind zu 5 Stück verpackt.
 F = ISO-Figur-Nr. · KL = Kopflänge in mm
 d = Durchmesser in 1/10 mm · P = Preiskategorie

All royal line FG diamonds are packed as 5 pieces.
 F = ISO-Shape-No. · hl = head length in mm
 d = diameter in 1/10 mm · P = price category

FG Diamanten – Royal line in 2-Lagen Diamantierung

FG diamonds – Royal line with two-layer diamond technology

ISO Nr.: 806 314 F 504 superfein / superfine

806 314 F 514 fein / fine

806 314 F 524 mittel / medium

806 314 F 534 grob / coarse

806 314 F 544 extragroß / extracoarse

Drehzahl / speed

30' - 300000 Upm / rpm

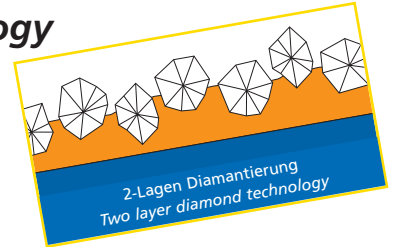

818	F:	040	040	040	040	040	040	040
	d:	012	016	023	027	033	042	050
	KL/hl:	0,4	0,5	0,9	1	1	1	1
	P:	1	1	2	2	3	3	3

909	F:	067
	d:	035
	KL/hl:	0,6
	P:	3

536818
536815

536738

536088

530965

536408

536418
536415

535988

531178

909	F:	068	068	068	068	068
	d:	032	037	040	042	055
	KL/hl:	1	1	1	1	2
	P:	3	3	3	3	3

909	F:	069	069	069
	d:	042	050	055
	KL/hl:	2,3	3,0	3,6
	P:	3	3	3

532726
532728

532725

532718
532715

532788

532738
532735

531188

532783

532768
532765

535818

532748

835	F:	108	108
	d:	008	009
	KL/hl:	3	3
	P:	1	1

835	F:	109	109	109	109
	d:	010	012	014	016
	KL/hl:	4	4	4	4
	P:	1	1	1	1

530608
530605

535518
535515

530616
530618

530615
530613

530628
530625
530623

530636
530638

530635
530633

535678
535675
535673

Alle Royal Line FG Diamanten sind zu 5 Stück verpackt.
F = ISO-Figur-Nr. · KL = Kopflänge in mm
d = Durchmesser in 1/10 mm · P = Preiskategorie

All royal line FG diamonds are packed as 5 pieces.
F = ISO-Shape-No. · hl = head length in mm
d = diameter in 1/10 mm · P = price category

FG Diamanten – Royal line in 2-Lagen Diamantierung

FG diamonds – Royal line with two-layer diamond technology

ISO Nr.: 806 314 F 504 superfein / superfine

806 314 F 514 fein / fine

806 314 F 524 mittel / medium



806 314 F 534 grob / coarse

806 314 F 544 extragroß / extracoarse

Drehzahl / speed

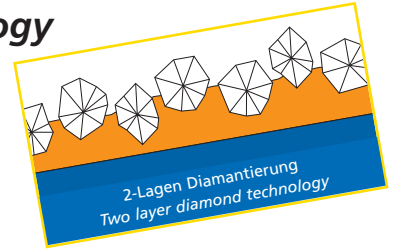
30' - 30000 Upm / rpm



		F :	110	110	110	110	110	110
		d :	008	010	012	014	016	018
		KL/hl :	6	6	6	6	6	6
		P :	1	1	1	1	1	1

531284

531288

531258

531255

531253

530646

530648

530645

530658

530655

530653



530654



531265

531263

531278

531275

		F :	111	111	111	111	111	111
		d :	010	012	014	016	018	025
		KL/hl :	8	8	8	8	8	8
		P :	1	1	1	1	1	2

		F :	112	112	112	112	112
		d :	010	012	014	016	018
		KL/hl :	10	10	10	10	10
		P :	1	1	1	1	1

531338

531335

531333

530756

530758

530755

530753

530666

530668

530665

530663

530676

530678

530675

530673

530688

530685

531348

531368

531378

531375

531386



531388



531385

530698

530695

531398

		F :	129
		d :	012
		KL/hl :	6
		P :	1

		F :	130	130	130	130	130
		d :	010	012	014	016	018
		KL/hl :	8	8	8	8	8
		P :	1	1	1	1	1

536588

536585

532408

532405

532414

532416

532418

532415

532413

532428

532425

532485

532435

Alle Royal Line FG Diamanten sind zu 5 Stück verpackt.
F = ISO-Figur-Nr. · KL = Kopflänge in mm
d = Durchmesser in 1/10 mm · P = Preiskategorie

All royal line FG diamonds are packed as 5 pieces.
F = ISO-Shape-No. · hl = head length in mm
d = diameter in 1/10 mm · P = price category

FG Diamanten – Royal line in 2-Lagen Diamantierung

FG diamonds – Royal line with two-layer diamond technology

ISO Nr.: 806 314 F 504 superfein / superfine

806 314 F 514 fein / fine

806 314 F 524 mittel / medium

806 314 F 534 grob / coarse

806 314 F 544 extragroß / extracoarse

Drehzahl / speed

30' - 300000 Upm / rpm

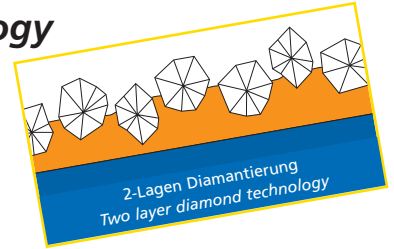

	 	F : 131	131	131
		d : 012	014	016
		KL/hl : 10	11	11
		P : 1	1	1
		886		

	 	F : 137	137	137	137
		d : 008	009	010	012
		KL/hl : 3,5	3,2	4	4
		P : 1	1	1	1
		838			

536628
536625
536623
532496
532498
532495
532446
532448
532445
532443

536028
536468
535778
535775
535773
535825
535823

	 	F : 139	139	139
		d : 008	010	014
		KL/hl : 4,5	4,5	4,5
		P : 1	1	1
		838		

	 	F : 140	140	140	140	140
		d : 010	012	014	016	018
		KL/hl : 6	6,5	6	6	6
		P : 1	1	1	1	1
		880				

530938
530944
530948
530945
530958

532458
532455
532466
532468
532465
532474
532476
532478
532475
532473
535918
535858

	 	F : 141	141	141	141	141
		d : 010	012	014	016	018
		KL/hl : 8,5	8,5	8,5	8,5	8,5
		P : 1	1	1	1	1
		881				

	 	F : 142	142	142
		d : 012	014	018
		KL/hl : 10,5	10,5	10,5
		P : 1	1	1
		882		

532556
532558
532555
532564
532566
532568
532565
532563
532574
532576
532578
532575
532573
532584
532586
532588
532585
532583
532654
532655
532653

532666
532668
532665
532678
532675
532688
532685

Alle Royal Line FG Diamanten sind zu 5 Stück verpackt.
F = ISO-Figur-Nr. · KL = Kopflänge in mm
d = Durchmesser in 1/10 mm · P = Preiskategorie

All royal line FG diamonds are packed as 5 pieces.
F = ISO-Shape-No. · hl = head length in mm
d = diameter in 1/10 mm · P = price category

FG Diamanten – Royal line in 2-Lagen Diamantierung

FG diamonds – Royal line with two-layer diamond technology

ISO Nr.: 806 314 F 504 superfein / superfine

806 314 F 514 fein / fine

806 314 F 524 mittel / medium







806 314 F 534 grob / coarse

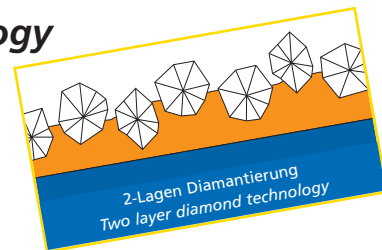





806 314 F 544 extragroß / extracoarse

Drehzahl / speed

30' - 300000 Upm / rpm



						
		F:	150	150	150	150
		d:	010	012	014	016
		KL/hl:	-	-	-	-
		P:	3	3	3	3

						
		F:	156	156	156	156
		d:	008	010	012	014
		KL/hl:	5	5	5	5
		P:	1	1	1	1



530706
530708

530718

530728





530738

530768







530778
530775

530786
530788

530785
530798
530795

					
		F:	157	157	157
		d:	010	012	014
		KL/hl:	6,5	6,5	6,5
		P:	1	1	1



						
		F:	158	158	158	158
		d:	010	012	014	016
		KL/hl:	8	8	8	8
		P:	1	1	1	1



530838

530848
530845





530858
530855





530868

530878
530875

530886
530888

530885
530883
533145

				
		F:	159	159
		d:	008	010
		KL/hl:	3	4
		P:	1	1

					
		F:	161	161	161
		d:	010	012	023
		KL/hl:	6	6	6
		P:	1	1	2

531454
531456

531444
531446

531476
531478

531304
531306
531308
531305

531488

Alle Royal Line FG Diamanten sind zu 5 Stück verpackt.
F = ISO-Figur-Nr. · KL = Kopflänge in mm
d = Durchmesser in 1/10 mm · P = Preiskategorie

All royal line FG diamonds are packed as 5 pieces.
F = ISO-Shape-No. · hl = head length in mm
d = diameter in 1/10 mm · P = price category

FG Diamanten – Royal line in 2-Lagen Diamantierung

FG diamonds – Royal line with two-layer diamond technology

ISO Nr.: 806 314 F 504 superfein / superfine

806 314 F 514 fein / fine

806 314 F 524 mittel / medium

806 314 F 534 grob / coarse

806 314 F 544 extragroß / extracoarse

Drehzahl / speed

30' - 300000 Upm / rpm

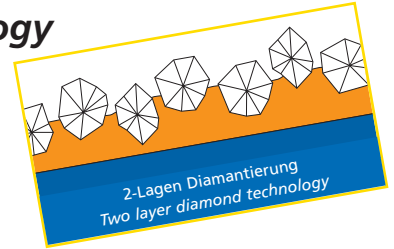

	F:	164	164	164	164	164
	d:	010	012	014	016	023
	KL/hl:	4	6	6	6	6
	P:	1	1	1	1	2

	F:	165	165	165	165	165
	d:	010	012	014	016	018
	KL/hl:	8	8	8	8	8
	P:	1	1	1	1	1

536564
536566
536568
536565
535584
535586
535588
535585
535583
531494
531496
535796
535798
536528

531666
531668
531324
531326
531328
531325
531314
531316
531318
531315
531313
531674
531676
531678
531675
533328
533325

	F:	166	166	166	166	166
	d:	010	012	014	016	018
	KL/hl:	10	10	10	10	10
	P:	1	1	1	1	2

	F:	167	167
	d:	010	018
	KL/hl:	11	11,5
	P:	1	1

535284
535286
535288
535285
535283
531874
531876
531878
531875
531873
531884
531886
531888
531885
531883
531894
531896
531898
531895
531893
531704
531706
531708
531705
531703
533805

530396
530398
531988

	F:	170	170	170	170	170
	d:	010	012	014	016	018
	KL/hl:	4	4	4	4	4
	P:	1	1	1	1	2

	F:	171	171	171	171
	d:	012	016	018	025
	KL/hl:	6	6	7	7
	P:	1	1	1	2

535926
535928
535925
532068
532065
532063
532078
532075
532073
530808
530805
535468
535478

532188
532185
532183
530816
530818
530815
530813
530828
530825
535528
535525

Alle Royal Line FG Diamanten sind zu 5 Stück verpackt.
F = ISO-Figur-Nr. · KL = Kopflänge in mm
d = Durchmesser in 1/10 mm · P = Preiskategorie

All royal line FG diamonds are packed as 5 pieces.
F = ISO-Shape-No. · hl = head length in mm
d = diameter in 1/10 mm · P = price category

FG Diamanten – Royal line in 2-Lagen Diamantierung

FG diamonds – Royal line with two-layer diamond technology

ISO Nr.: 806 314 F 504 superfein / superfine

806 314 F 514 fein / fine

806 314 F 524 mittel / medium

806 314 F 534 grob / coarse

806 314 F 544 extragroß / extracoarse

Drehzahl / speed

30' - 300000 Upm / rpm

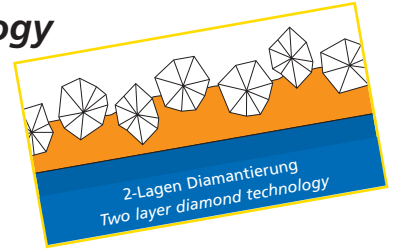

847	F:	172	172	172	172	172
	d:	012	014	016	018	021
	KL/hl:	8	8	8	8	8
	P:	1	1	1	1	2

848	F:	173	173	173	173	173	173	173
	d:	010	012	014	016	018	023	025
	KL/hl:	10	10	10	10	10	10	10
	P:	1	1	1	1	1	2	2

848L	F:	174	174	174	174
	d:	012	014	016	018
	KL/hl:	11,5	11,5	11,5	11,5
	P:	1	1	1	1

846L	F:	183
	d:	025
	KL/hl:	7
	P:	2

957	F:	195	195
	d:	007	009
	KL/hl:	3	3
	P:	1	1

532636
532638
532635
531046
531048
531045
531043
531058
531055
531053
531068
531065
531063

532648
532645

532954
532956
532964
532966

Alle Royal Line FG Diamanten sind zu 5 Stück verpackt.
F = ISO-Figur-Nr. · KL = Kopflänge in mm
d = Durchmesser in 1/10 mm · P = Preiskategorie

All royal line FG diamonds are packed as 5 pieces.
F = ISO-Shape-No. · hl = head length in mm
d = diameter in 1/10 mm · P = price category

FG Diamanten – Royal line in 2-Lagen Diamantierung

FG diamonds – Royal line with two-layer diamond technology

ISO Nr.: 806 314 F 504 superfein / superfine

806 314 F 514 fein / fine

806 314 F 524 mittel / medium

806 314 F 534 grob / coarse

806 314 F 544 extragroß / extracoarse

Drehzahl / speed

30' - 30000 Upm / rpm

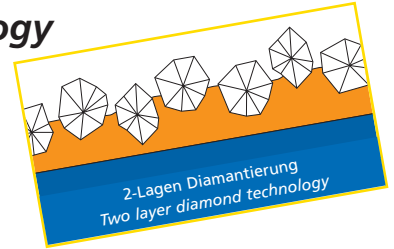

		F :	196	196	196
		d :	009	010	012
		KL/hl :	4	4	4
		P :	1	1	1
		849			

		F :	197	197	197	197
		d :	009	012	014	016
		KL/hl :	5	6	6	6
		P :	1	1	1	1
		855				

536484

536488

536638

536635

536298

536295

536293

531438

531406

531408

531405

531403

531416

531418

531415

531428

		F :	198	198	198	198	198	198	198	198	198	198
		d :	010	012	014	016	018	021	023	025		
		KL/hl :	8	8	8	8	8	8	8	8		
		P :	1	1	1	1	1	2	2	2		
		856										

		F :	198L	198L
		d :	012	023
		KL/hl :	9	9
		P :	1	2
		856L		

533118

533124

533126

533128

533125

533123

533104

533106

533108

533105

533103

531504

531506

531508

531505

531503

531514

531516

531518

531515

531513

531524

531526

531528

531525

531523

531586

531588

531585

531583

531598

531595

531593

535148

535145

535138

		F :	199	199	199	199	199	199	199	199	199
		d :	010	012	014	016	018	020	023	024	
		KL/hl :	10	10	10	10	10	10	10	10	
		P :	1	1	1	1	1	2	2	2	
		850									

531104

531106

531108

531105

531114

531116

531118

531115

531124

531126

531128

531125

531134

531136

531138

531135

531144

531146

531148

531145

531195

535406

535408

535405

535403

535408C

Alle Royal Line FG Diamanten sind zu 5 Stück verpackt.
F = ISO-Figur-Nr. · KL = Kopflänge in mm
d = Durchmesser in 1/10 mm · P = Preiskategorie

All royal line FG diamonds are packed as 5 pieces.
F = ISO-Shape-No. · hl = head length in mm
d = diameter in 1/10 mm · P = price category

FG Diamanten – Royal line in 2-Lagen Diamantierung

FG diamonds – Royal line with two-layer diamond technology

ISO Nr.: 806 314 F 504 superfein / superfine

806 314 F 514 fein / fine

806 314 F 524 mittel / medium



806 314 F 534 grob / coarse

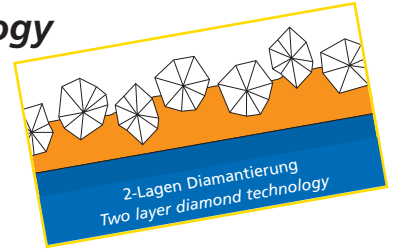

806 314 F 544 extragroß / extracoarse

Drehzahl / speed

30' - 300000 Upm / rpm







 850L		F :	200	200	200	200
		d :	012	014	016	018
		KL/hl :	11,5	11,5	11,5	11,5
		P :	1	1	1	1

 850L		F :	201	201
		d :	014	018
		KL/hl :	9	9
		P :	1	1

533228
533225
533238
533235
531156
531158
531155
531166
531168
531165
531163



533278
533275
533288
533285



 879K		F :	213
		d :	016
		KL/hl :	10
		P :	1



 851	 	F :	219	219	219	219
		d :	012	014	016	018
		KL/hl :	8	8	8	8
		P :	1	1	1	1

533368
533365

531206
531208
531205
536728
536725
531296
531298
531295
533168

 857		F :	220	220	220
		d :	012	014	016
		KL/hl :	10	10	10
		P :	1	1	1

 869K		F :	222
		d :	014
		KL/hl :	6
		P :	1

 868K		F :	223	223
		d :	012	016
		KL/hl :	8	8
		P :	1	1

531688
531685
531606
531608
531605
531698
531695

536928

536906
536908
536918

Alle Royal Line FG Diamanten sind zu 5 Stück verpackt.
F = ISO-Figur-Nr. · KL = Kopflänge in mm
d = Durchmesser in 1/10 mm · P = Preiskategorie

All royal line FG diamonds are packed as 5 pieces.
F = ISO-Shape-No. · hl = head length in mm
d = diameter in 1/10 mm · P = price category

FG Diamanten – Royal line in 2-Lagen Diamantierung

FG diamonds – Royal line with two-layer diamond technology

ISO Nr.: 806 314 F 504 superfein / superfine

806 314 F 514 fein / fine

806 314 F 524 mittel / medium





806 314 F 534 grob / coarse

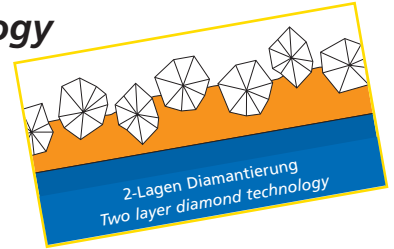

806 314 F 544 extragroß / extracoarse

Drehzahl / speed

30' - 300000 Upm / rpm



	  	F : 225	225	225	225	225
		d : 010	012	014	016	018
		KL/hl : 3	3,5	3,5	4	5
		P : 1	1	1	1	1

	 	F : 232
		d : 009
		KL/hl : 2
		P : 1

535498

533408

533405

533403

533418

533415



533428



533425



530518

530515

533438

	 	F : 233	233
		d : 010	012
		KL/hl : 3	3
		P : 1	1

	 	F : 234	234	234
		d : 012	014	016
		KL/hl : 4	5	5
		P : 1	1	1

	 	F : 236	236	236
		d : 012	014	016
		KL/hl : 5,5	5,5	5,5
		P : 1	1	1

533508

533518

533515

531658

531655

531616

531618

531615

531628



531625



536865

536875

536888

536885

	 	F : 237	237	237
		d : 008	009	010
		KL/hl : 2,5	2,5	2,5
		P : 1	1	1

	 	F : 238	238	238	238	238	238
		d : 009	010	012	012	014	016
		KL/hl : 3	3	3	4,5	3	3
		P : 1	1	1	1	1	1

530408

530405

536248

530418

530415

535768

535246

535248

535245

530426

530428

530425

533348

533345

535934

535936

535938

535935

535896

535898

535895

Alle Royal Line FG Diamanten sind zu 5 Stück verpackt.
F = ISO-Figur-Nr. · KL = Kopflänge in mm
d = Durchmesser in 1/10 mm · P = Preiskategorie

All royal line FG diamonds are packed as 5 pieces.
F = ISO-Shape-No. · hl = head length in mm
d = diameter in 1/10 mm · P = price category

FG Diamanten – Royal line in 2-Lagen Diamantierung

FG diamonds – Royal line with two-layer diamond technology

ISO Nr.: 806 314 F 504 superfein / superfine

806 314 F 514 fein / fine

806 314 F 524 mittel / medium

806 314 F 534 grob / coarse

806 314 F 544 extragroß / extracoarse

Drehzahl / speed

30' - 300000 Upm / rpm

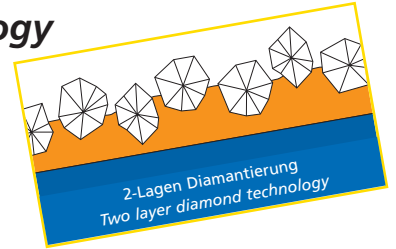

						F :	239	239	239	239	239
						d :	012	014	016	018	025
						KL/hl :	5,5	5,5	5,5	5,5	5
						P :	1	1	1	1	2

		F :	245
		d :	014
		KL/hl :	5
		P :	1

530434
530436
530438
530435
530433
530443
530445
530448
530453
530455
530458
530468
530465
535278

533616
533618
533615

		F :	247	247	247	247	247
		d :	009	010	012	016	018
		KL/hl :	3,7	4,5	4,5	6	6
		P :	1	1	1	1	1

		F :	248	248
		d :	012	014
		KL/hl :	6	6
		P :	1	1

532618
536228
536225
533604
533606
533608
533605
536538
536608

531806
531808
531818
531815

		F :	249	249	249	249	249
		d :	010	012	014	016	018
		KL/hl :	8	8	8	8	8
		P :	1	1	1	1	1

531864
531866
531868
531865
531863
531824
531826
531828
531825
531823
531834
531836
531838
531835
531833
531844
531846
531848
531845
531843
531858

Alle Royal Line FG Diamanten sind zu 5 Stück verpackt.
F = ISO-Figur-Nr. · KL = Kopflänge in mm
d = Durchmesser in 1/10 mm · P = Preiskategorie

All royal line FG diamonds are packed as 5 pieces.
F = ISO-Shape-No. · hl = head length in mm
d = diameter in 1/10 mm · P = price category

FG Diamanten – Royal line in 2-Lagen Diamantierung

FG diamonds – Royal line with two-layer diamond technology

ISO Nr.: 806 314 F 504 superfein / superfine

806 314 F 514 fein / fine

806 314 F 524 mittel / medium



806 314 F 534 grob / coarse

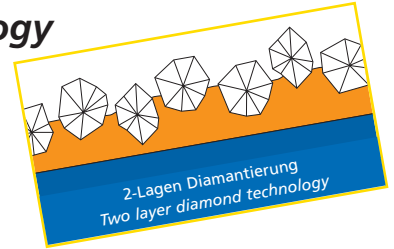

806 314 F 544 extragroß / extracoarse

Drehzahl / speed

30' - 300000 Upm / rpm





		F:	250	250	250	250	250	250
		d:	010	012	014	016	018	021
		KL/hl:	10	10	10	10	10	10
		P:	1	1	1	1	1	2
		863						



		F:	251	251	251
		d:	014	016	018
		KL/hl:	12	11,6	11,5
		P:	1	1	1
		864			

531964
531966
531968
531965
531904
531906
531908
531905
531903
531916
531918
531915
531924
531926
531928
531925
531923
531938
531935
531933

535784
535786
535788
531946
531945
531943
531955
531953

		F:	255
		d:	012
		KL/hl:	6
		P:	1
		861	

		F:	256
		d:	012
		KL/hl:	10
		P:	1
		863A	



		F:	257	257	257	257	257	257
		d:	010	014	016	018	021	023
		KL/hl:	3,5	3,5	3,5	4,5	5	5
		P:	1	1	1	1	2	2
		368						



534268



534308

532876
532878

536758
532804
532806
532808
532805
532803
532814
532816
532818
532815
536594
536596
536598
536595
532824
532826
532828
532825
532823

		F:	263
		d:	025
		KL/hl:	5,5
		P:	2
		369	

		F:	269
		d:	016
		KL/hl:	8
		P:	1
		847	

		F:	271	271
		d:	016	020
		KL/hl:	2,7	4,0
		P:	1	2
		390		

533706
533708
533705

532834
532836
532838
532835

533004
533006
533008
533005
530564
530566

Alle Royal Line FG Diamanten sind zu 5 Stück verpackt.
F = ISO-Figur-Nr. · KL = Kopflänge in mm
d = Durchmesser in 1/10 mm · P = Preiskategorie

All royal line FG diamonds are packed as 5 pieces.
F = ISO-Shape-No. · hl = head length in mm
d = diameter in 1/10 mm · P = price category

FG Diamanten – Royal line in 2-Lagen Diamantierung

FG diamonds – Royal line with two-layer diamond technology

ISO Nr.: 806 314 F 504 superfein / superfine

806 314 F 514 fein / fine

806 314 F 524 mittel / medium

806 314 F 534 grob / coarse

806 314 F 544 extragroß / extracoarse

Drehzahl / speed

30' - 300000 Upm / rpm

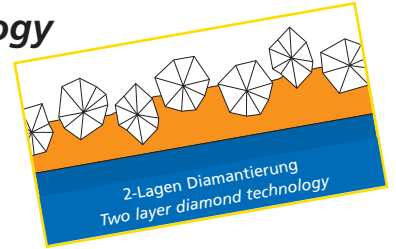

		F : 274
		d : 016
		KL/hl : 3,5
		P : 1
		390

533624
533626
533628

		F : 277	F : 277	F : 277	F : 277	F : 277
		d : 012	d : 014	d : 016	d : 018	d : 023
		KL/hl : 3,2	KL/hl : 3,5	KL/hl : 3,5	KL/hl : 5	KL/hl : 5
		P : 1	P : 1	P : 1	P : 1	P : 2
		379				

532906
532908
532934
532936
532938
532935
532946
532948
532945
532914
532916
532918
532915
532913
532924
532926
532928
532925

		F : 288	F : 288
		d : 010	d : 012
		KL/hl : 6	KL/hl : 6
		P : 1	P : 1
		877	

533208
533205
535848
535845

		F : 289	F : 289	F : 289	F : 289	F : 289
		d : 010	d : 012	d : 014	d : 016	d : 018
		KL/hl : 8	KL/hl : 7,5	KL/hl : 8	KL/hl : 8	KL/hl : 8
		P : 1	P : 1	P : 1	P : 1	P : 1
		878				

532136
532138
532135
532133
532146
532148
532145
532143
532106
532108
532105
532116
532118
532115
532113
532126
532128
532125

		F : 290	F : 290	F : 290	F : 290	F : 290
		d : 010	d : 012	d : 014	d : 016	d : 018
		KL/hl : 10	KL/hl : 10	KL/hl : 10	KL/hl : 10	KL/hl : 10
		P : 1	P : 1	P : 1	P : 1	P : 1
		879				

532166
532168
532165
532156
532158
532155
532153
532504
532506
532508
532505
532503
532516
532518
532515
532513
532528
532525

		F : 297	F : 297	F : 297	F : 297
		d : 012	d : 014	d : 016	d : 018
		KL/hl : 6	KL/hl : 6	KL/hl : 6	KL/hl : 6
		P : 1	P : 1	P : 1	P : 1
		877K			

532014
532008
532005
532018
532015
532028
532025
532023
532038

Alle Royal Line FG Diamanten sind zu 5 Stück verpackt.
F = ISO-Figur-Nr. · KL = Kopflänge in mm
d = Durchmesser in 1/10 mm · P = Preiskategorie

All royal line FG diamonds are packed as 5 pieces.
F = ISO-Shape-No. · hl = head length in mm
d = diameter in 1/10 mm · P = price category

FG Diamanten – Royal line in 2-Lagen Diamantierung

FG diamonds – Royal line with two-layer diamond technology

ISO Nr.: 806 314 F 504 superfein / superfine

806 314 F 514 fein / fine

806 314 F 524 mittel / medium

806 314 F 534 grob / coarse

806 314 F 544 extragrob / extracoarse

Drehzahl / speed

30' - 300000 Upm / rpm

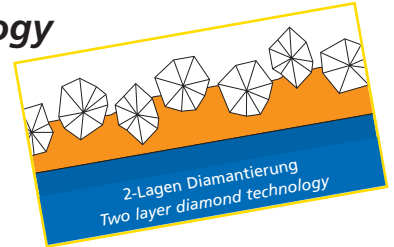

		F:	298	298	298	298	298
		d:	012	014	016	018	020
		KL/hl:	8	8	8	8	8
		P:	1	1	1	1	2

		F:	299	299	299	299	299
		d:	012	014	016	018	021
		KL/hl:	10	10	10	10	10
		P:	1	1	1	1	2

- 532208
- 532205
- 532218
- 532215
- 532213
- 532226
- 532228
- 532225
- 532223
- 532238
- 532235
- 532233
- 532345

- 532308
- 532305
- 532316
- 532318
- 532315
- 532328
- 532325
- 532323
- 532336
- 532338
- 532335
- 532333
- 532368
- 532365

		F:	304	304	304
		d:	018	025	040
		KL/hl:	0,7	0,9	1,3
		P:	1	2	3

		F:	463
		d:	025
		KL/hl:	1,5
		P:	2

		F:	465
		d:	016
		KL/hl:	5
		P:	1

- 536448
- 536268
- 536438
- 534358
- 533746
- 533748

		F:	466	466
		d:	022	023
		KL/hl:	4,5	3,5
		P:	2	2

		F:	466
		d:	031
		KL/hl:	3,5
		P:	3

		F:	496
		d:	012
		KL/hl:	8
		P:	1

- 532894
- 532896
- 532884
- 532886
- 532716
- 532718
- 532775
- 535944
- 535948
- 535945

Alle Royal Line FG Diamanten sind zu 5 Stück verpackt.
 F = ISO-Figur-Nr. · KL = Kopflänge in mm
 d = Durchmesser in 1/10 mm · P = Preiskategorie

All royal line FG diamonds are packed as 5 pieces.
 F = ISO-Shape-No. · hl = head length in mm
 d = diameter in 1/10 mm · P = price category

FG Diamanten – Royal line in 2-Lagen Diamantierung

FG diamonds – Royal line with two-layer diamond technology

ISO Nr.: 806 314 F 504 *superfein / superfine*

806 314 F 514 *fein / fine*

806 314 F 524 *mittel / medium*









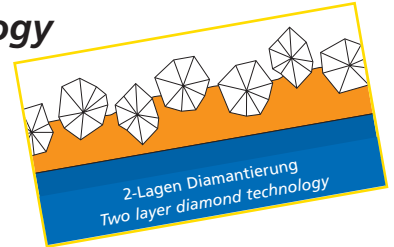





806 314 F 534 *grob / coarse*











806 314 F 544 *extragrob / extracoarse*





Drehzahl / speed

30' - 30000 Upm / rpm



 370 <table border="0"> <tr><td>F :</td><td>507</td></tr> <tr><td>d :</td><td>023</td></tr> <tr><td>KL/hl :</td><td>6</td></tr> <tr><td>P :</td><td>2</td></tr> </table>	F :	507	d :	023	KL/hl :	6	P :	2	 883 <table border="0"> <tr><td>F :</td><td>536</td></tr> <tr><td>d :</td><td>010</td></tr> <tr><td>KL/hl :</td><td>3</td></tr> <tr><td>P :</td><td>1</td></tr> </table>	F :	536	d :	010	KL/hl :	3	P :	1	 889 <table border="0"> <tr><td>F :</td><td>540</td><td>540</td></tr> <tr><td>d :</td><td>009</td><td>010</td></tr> <tr><td>KL/hl :</td><td>3,5</td><td>4,5</td></tr> <tr><td>P :</td><td>1</td><td>1</td></tr> </table>	F :	540	540	d :	009	010	KL/hl :	3,5	4,5	P :	1	1
F :	507																													
d :	023																													
KL/hl :	6																													
P :	2																													
F :	536																													
d :	010																													
KL/hl :	3																													
P :	1																													
F :	540	540																												
d :	009	010																												
KL/hl :	3,5	4,5																												
P :	1	1																												
 536806  536808	 536988	 532604  532606  532608  532605  536034  536036  536038  536035																												

 845KR <table border="0"> <tr><td>F :</td><td>544</td><td>544</td><td>544</td></tr> <tr><td>d :</td><td>016</td><td>018</td><td>025</td></tr> <tr><td>KL/hl :</td><td>4</td><td>4</td><td>4</td></tr> <tr><td>P :</td><td>1</td><td>1</td><td>2</td></tr> </table>	F :	544	544	544	d :	016	018	025	KL/hl :	4	4	4	P :	1	1	2	 846KR <table border="0"> <tr><td>F :</td><td>545</td><td>545</td></tr> <tr><td>d :</td><td>016</td><td>018</td></tr> <tr><td>KL/hl :</td><td>6</td><td>6</td></tr> <tr><td>P :</td><td>1</td><td>1</td></tr> </table>	F :	545	545	d :	016	018	KL/hl :	6	6	P :	1	1
F :	544	544	544																										
d :	016	018	025																										
KL/hl :	4	4	4																										
P :	1	1	2																										
F :	545	545																											
d :	016	018																											
KL/hl :	6	6																											
P :	1	1																											
 534168  532845  532858  532855	 534186  534188  534185  532868  532865																												

 847KR <table border="0"> <tr><td>F :</td><td>546</td></tr> <tr><td>d :</td><td>016</td></tr> <tr><td>KL/hl :</td><td>8</td></tr> <tr><td>P :</td><td>1</td></tr> </table>	F :	546	d :	016	KL/hl :	8	P :	1	 959KR <table border="0"> <tr><td>F :</td><td>584</td></tr> <tr><td>d :</td><td>018</td></tr> <tr><td>KL/hl :</td><td>5,5</td></tr> <tr><td>P :</td><td>1</td></tr> </table>	F :	584	d :	018	KL/hl :	5,5	P :	1
F :	546																
d :	016																
KL/hl :	8																
P :	1																
F :	584																
d :	018																
KL/hl :	5,5																
P :	1																
 534208  534205	 534126																

Alle Royal Line FG Diamanten sind zu 5 Stück verpackt.
 F = ISO-Figur-Nr. · KL = Kopflänge in mm
 d = Durchmesser in 1/10 mm · P = Preiskategorie

All royal line FG diamonds are packed as 5 pieces.
 F = ISO-Shape-No. · hl = head length in mm
 d = diameter in 1/10 mm · P = price category

FG Diamanten – Royal line in 2-Lagen Diamantierung

FG diamonds – Royal line with two-layer diamond technology

ISO Nr.: 806 315 F 504 superfein / superfine

806 315 F 514 fein / fine

806 315 F 524 mittel / medium

806 315 F 534 grob / coarse

806 315 F 544 extragroß / extracoarse

Drehzahl / speed

30' - 300000 Upm / rpm

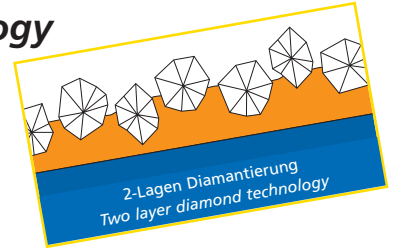

801L	F :	697	697	697	697	697	697	697
	d :	012	014	016	018	021	023	027
	KL/hl :	1,2	1,4	1,6	1,8	2,1	2,3	2,7
	P :	1	1	1	1	2	2	3



FG Diamanten – Royal line in 2-Lagen Diamantierung

mit Tiefenmarkierung zur Inlaypräparation

FG diamonds – Royal line with two-layer diamond technology with depth marker for inlay preparation

ISO Nr.: 806 314 F 504 superfein / superfine

806 314 F 514 fein / fine

806 314 F 524 mittel / medium

806 314 F 534 grob / coarse

806 314 F 544 extragroß / extracoarse

Drehzahl / speed

30' - 300000 Upm / rpm

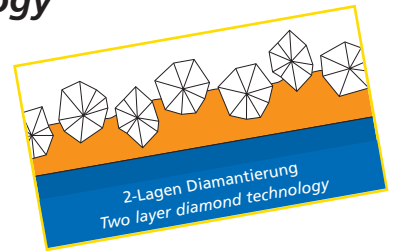

845KR	F :	544
	d :	025
	KL/hl :	4
	P :	2

846KR	F :	545
	d :	018
	KL/hl :	6
	P :	1

847KR	F :	546
	d :	018
	KL/hl :	5,5
	P :	1

532858L

532868L

534128L

Alle Royal Line FG Diamanten sind zu 5 Stück verpackt.
F = ISO-Figur-Nr. · KL = Kopflänge in mm
d = Durchmesser in 1/10 mm · P = Preiskategorie

All royal line FG diamonds are packed as 5 pieces.
F = ISO-Shape-No. · hl = head length in mm
d = diameter in 1/10 mm · P = price category